

A-A

ШТВ-2-30.10.9-4.3A3

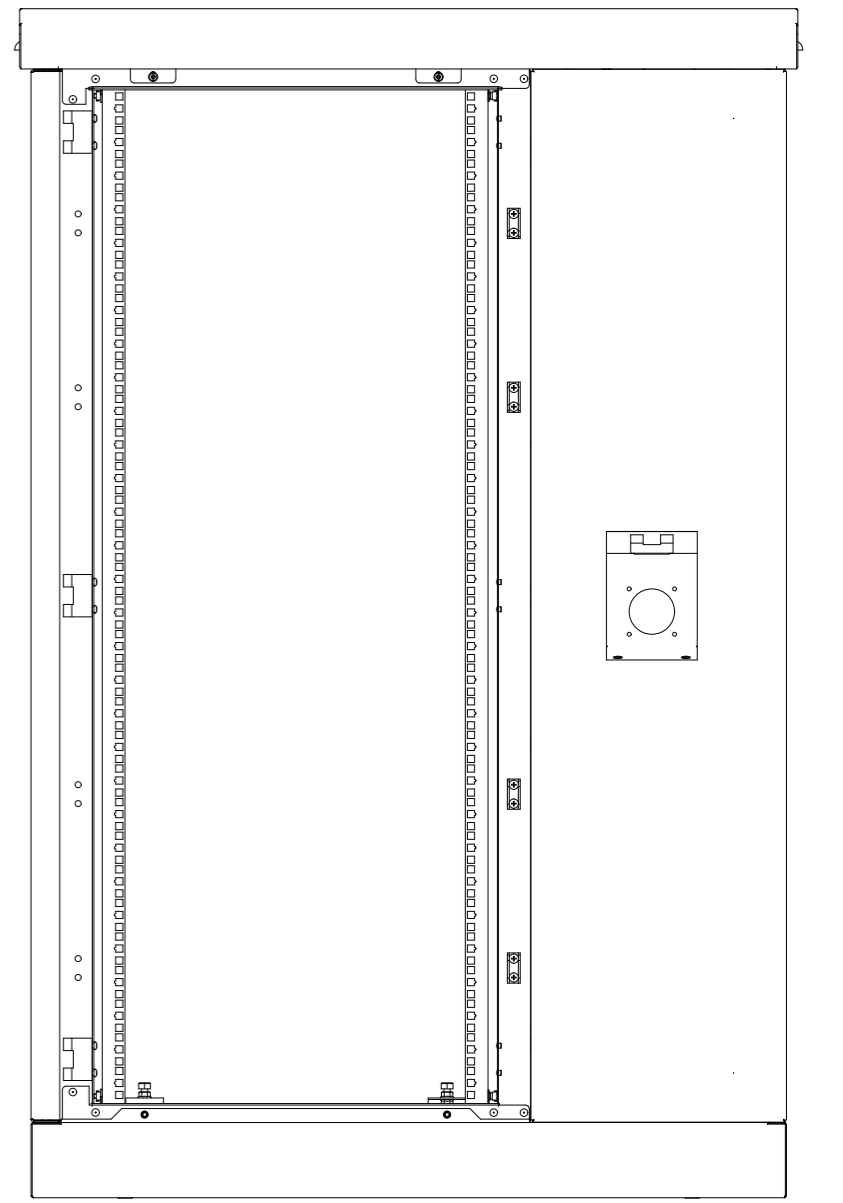
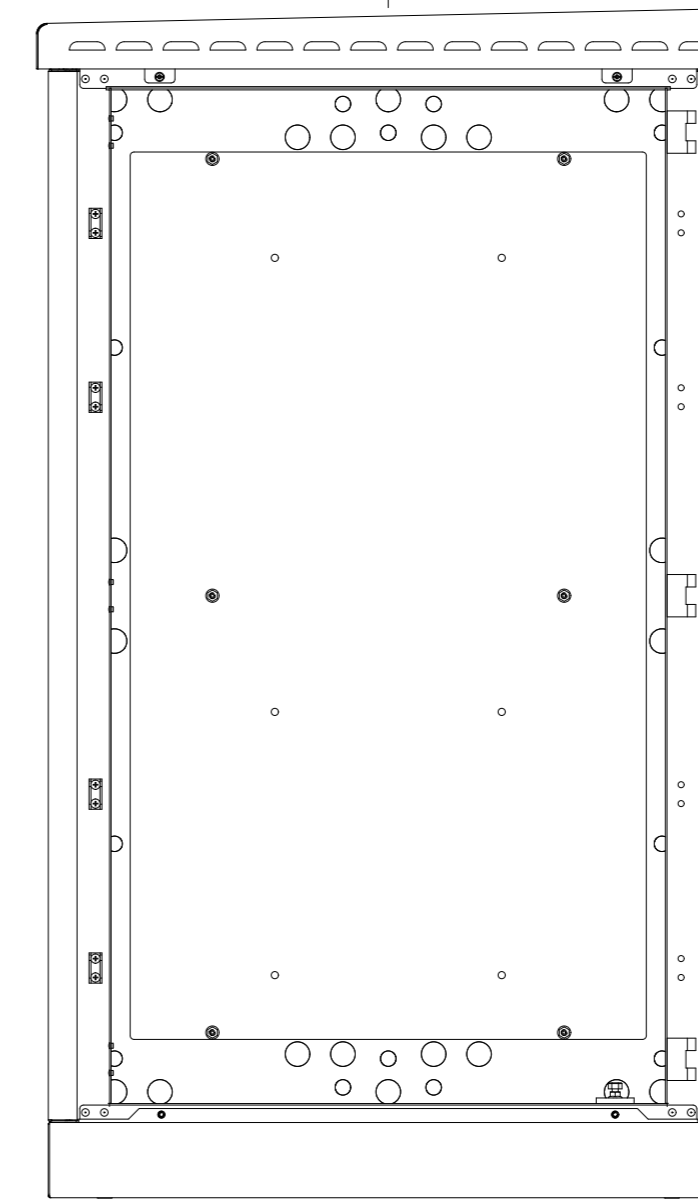
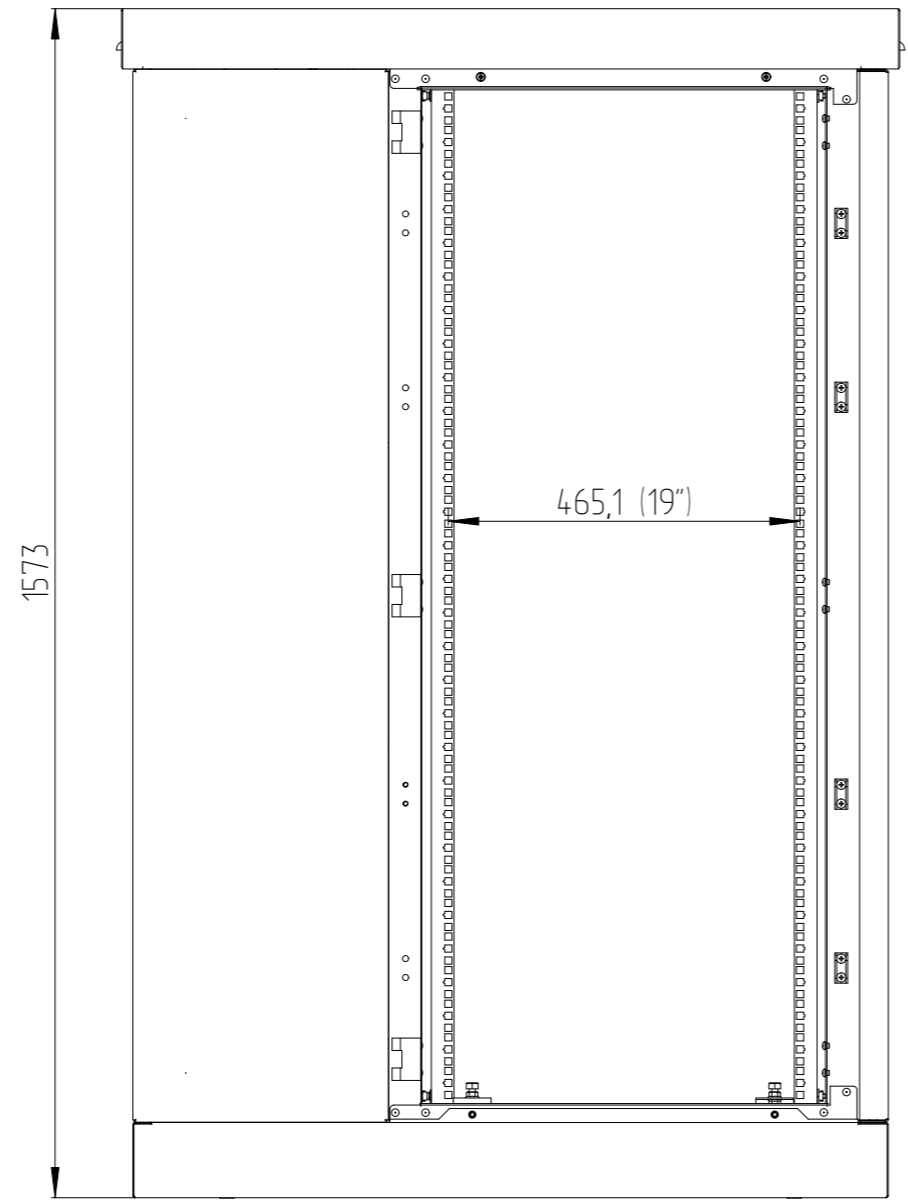
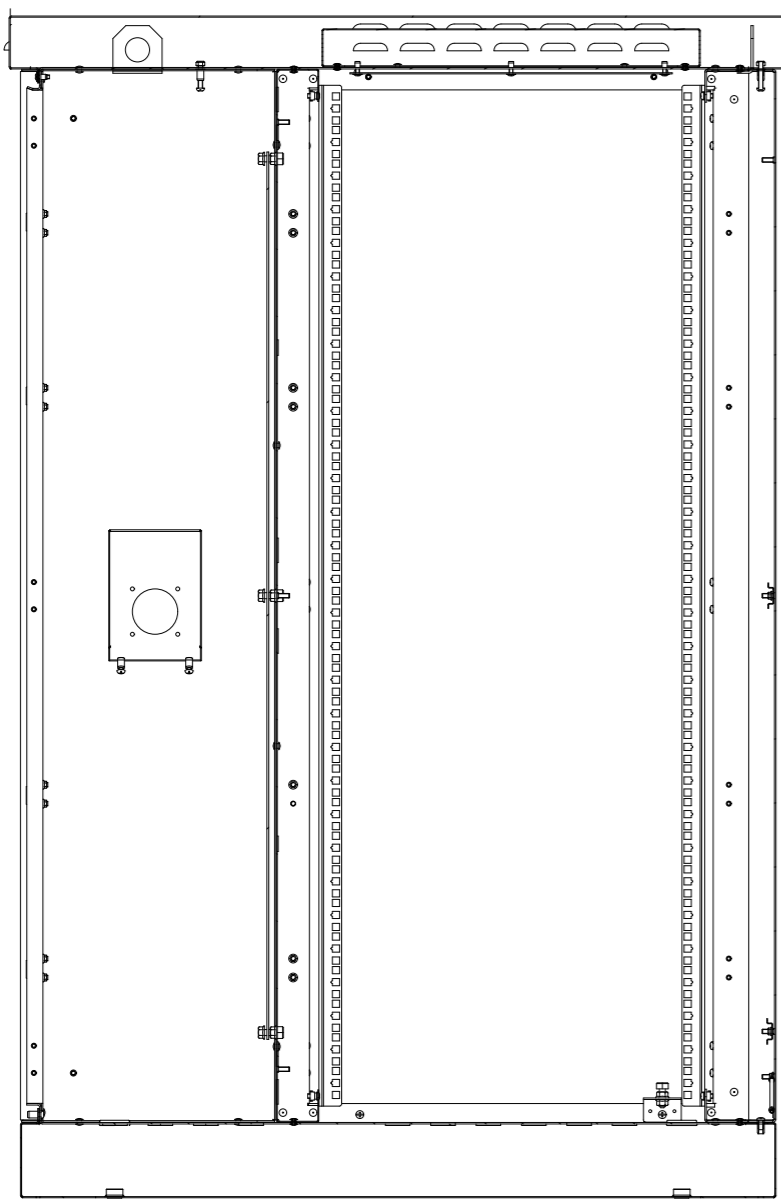

A-A

ШТВ-2-36.10.9-4.3A3

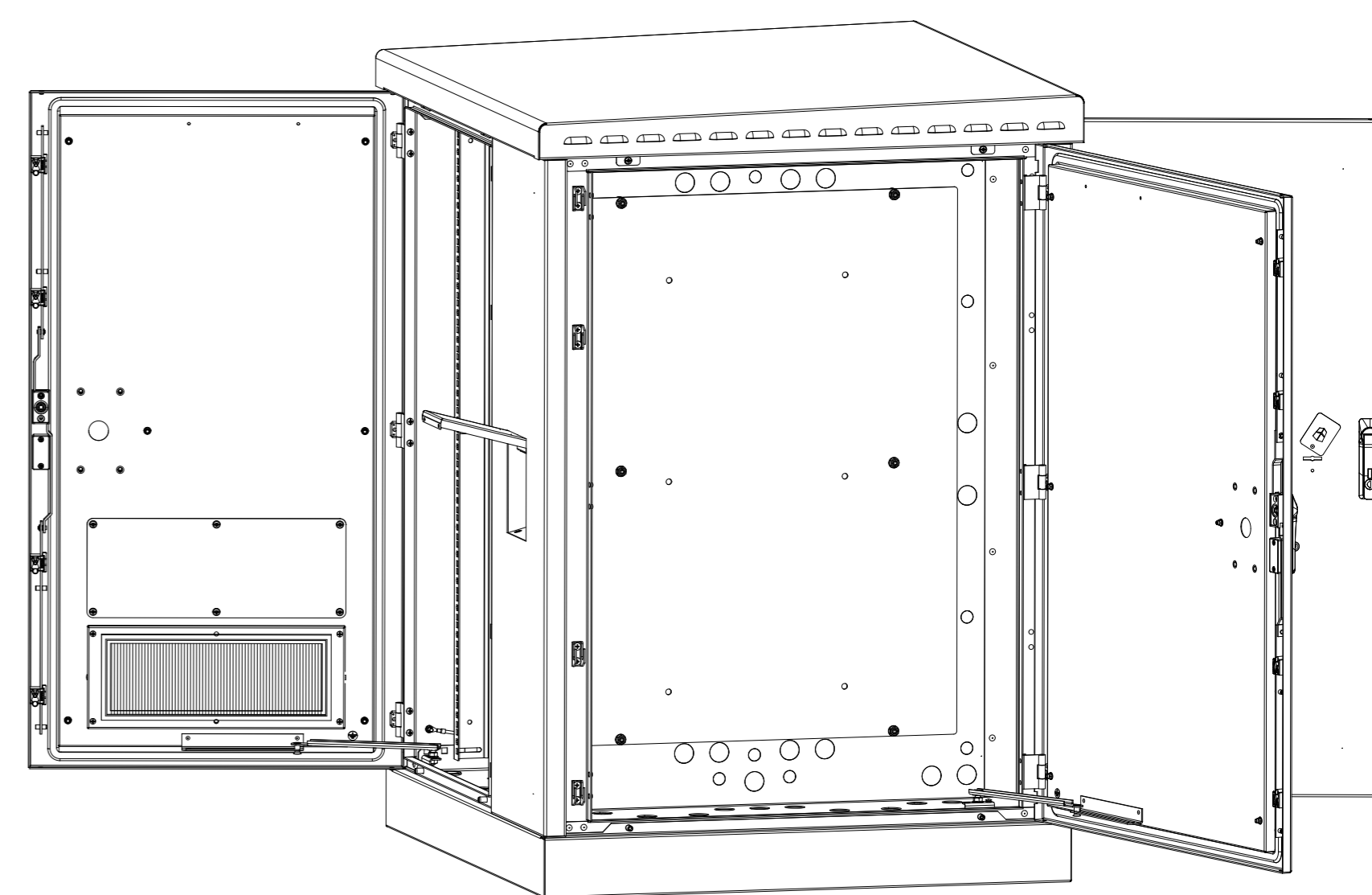
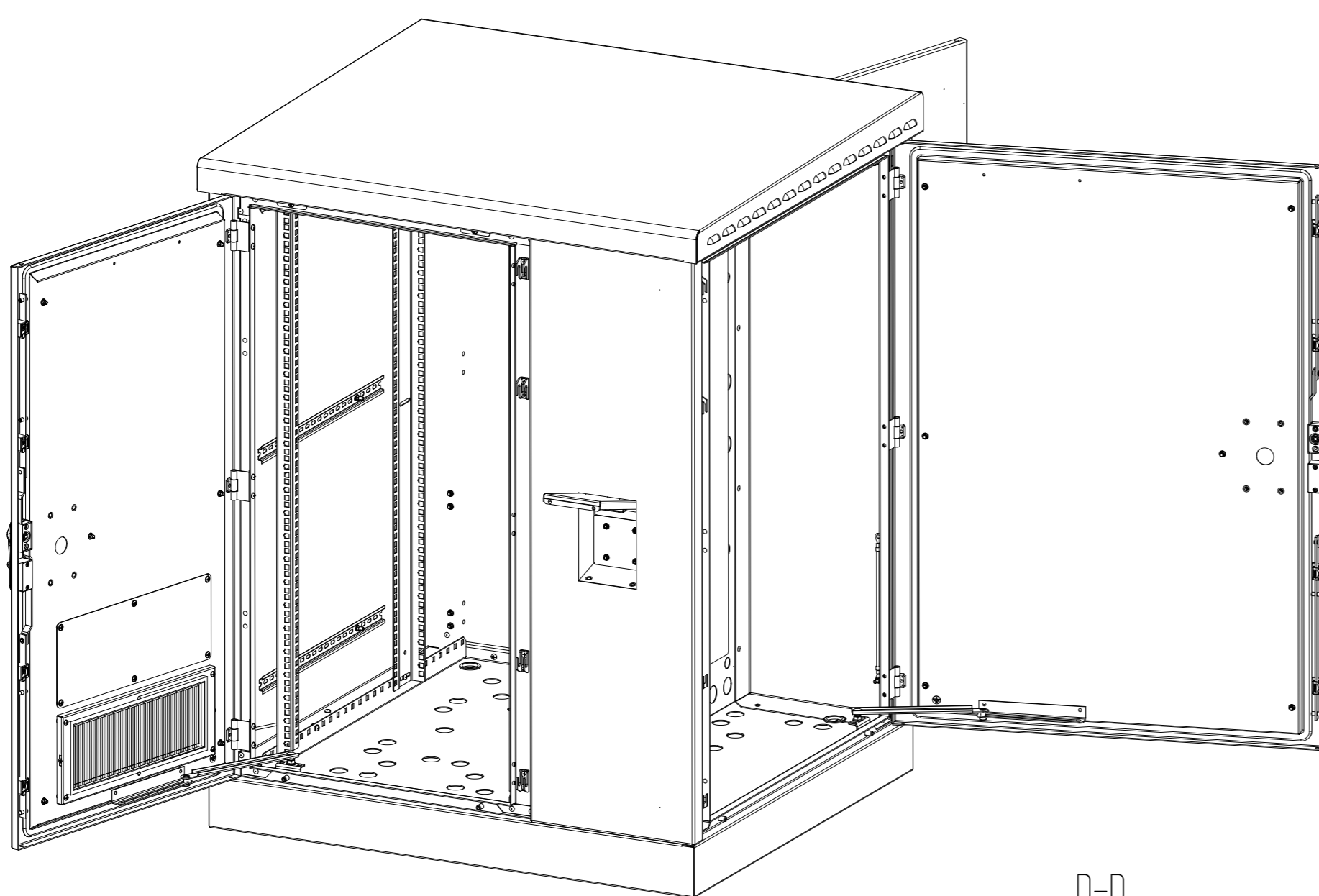
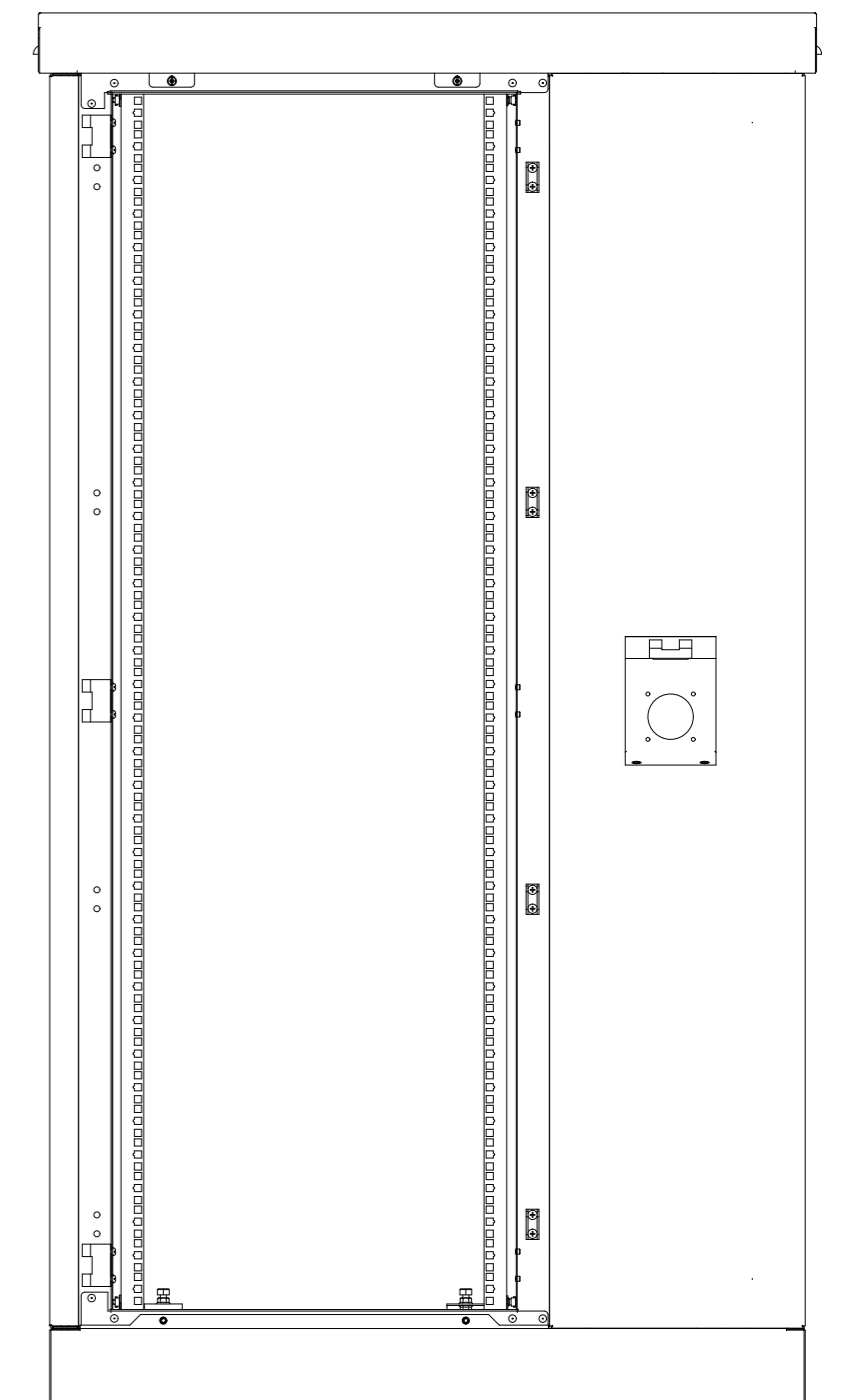
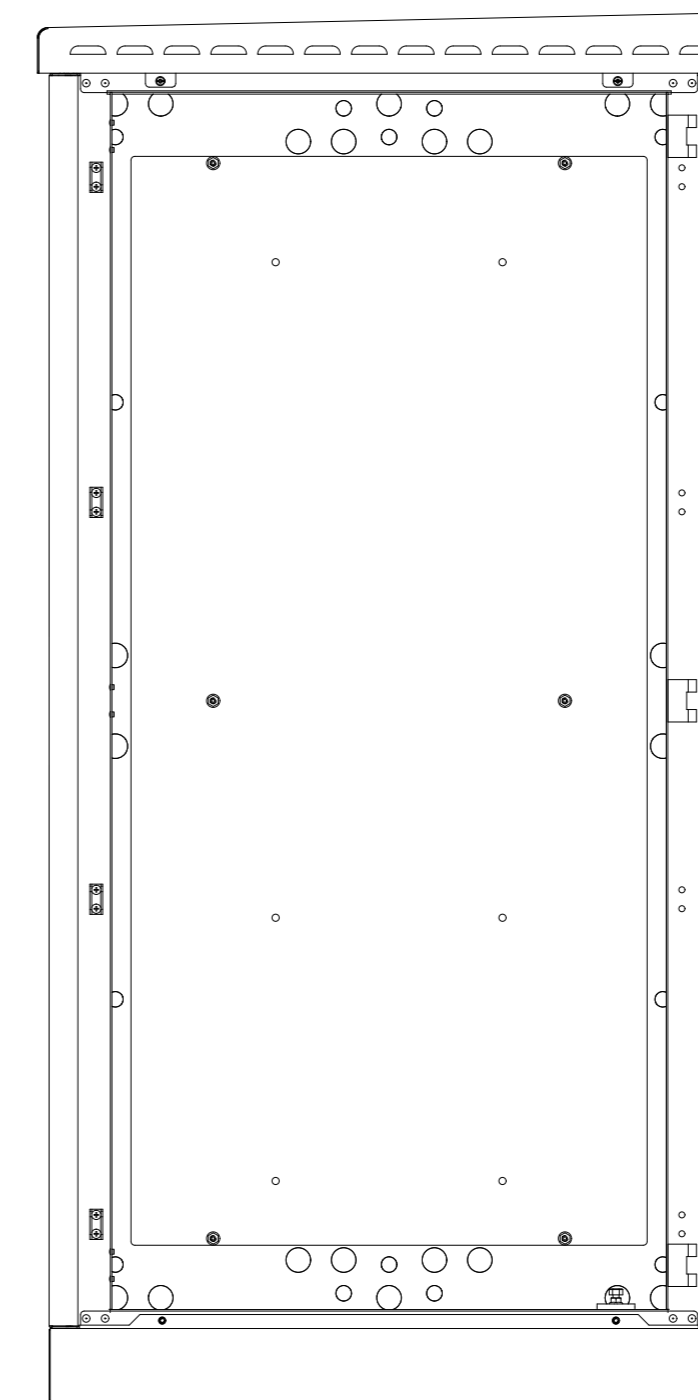
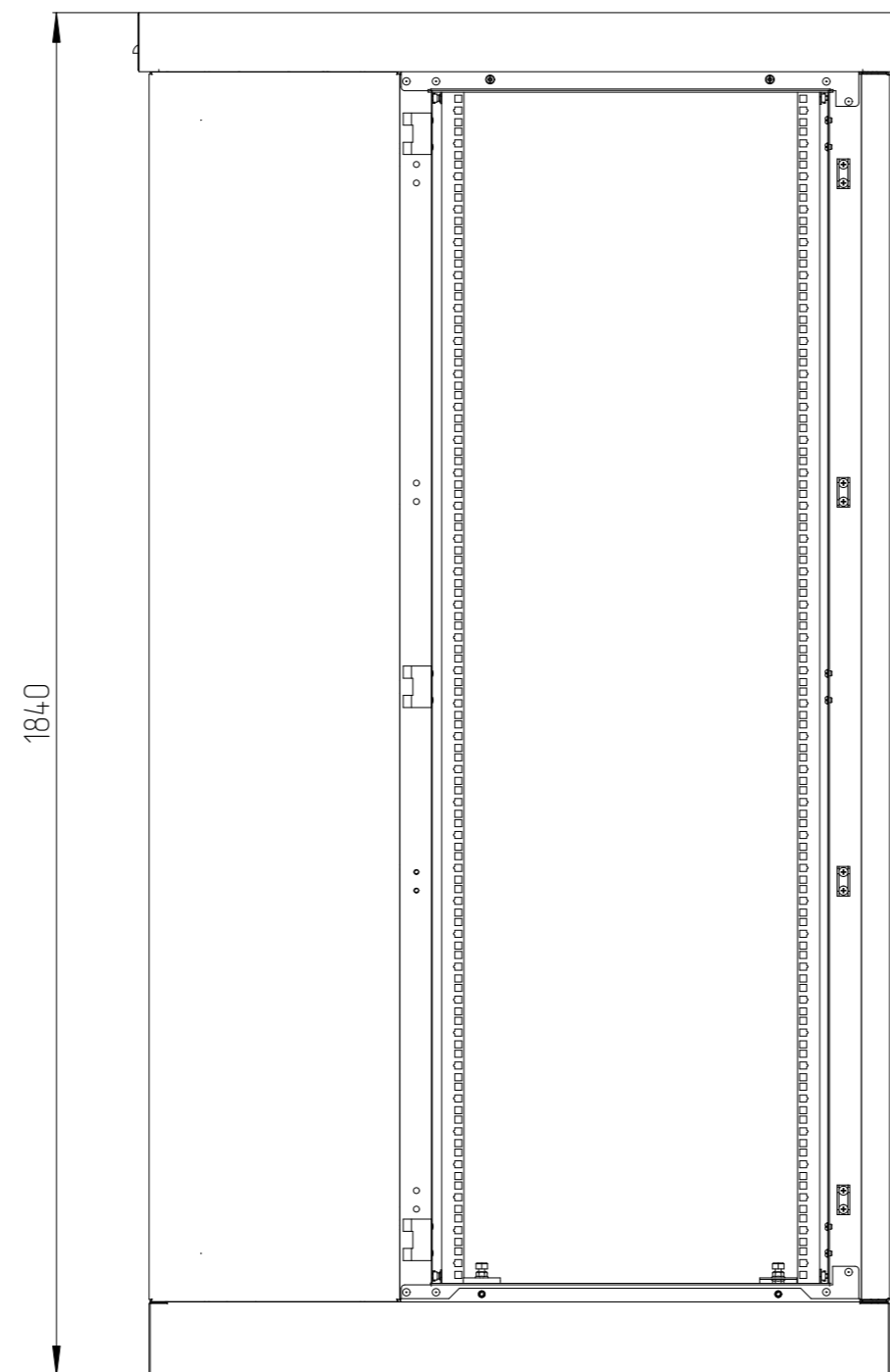
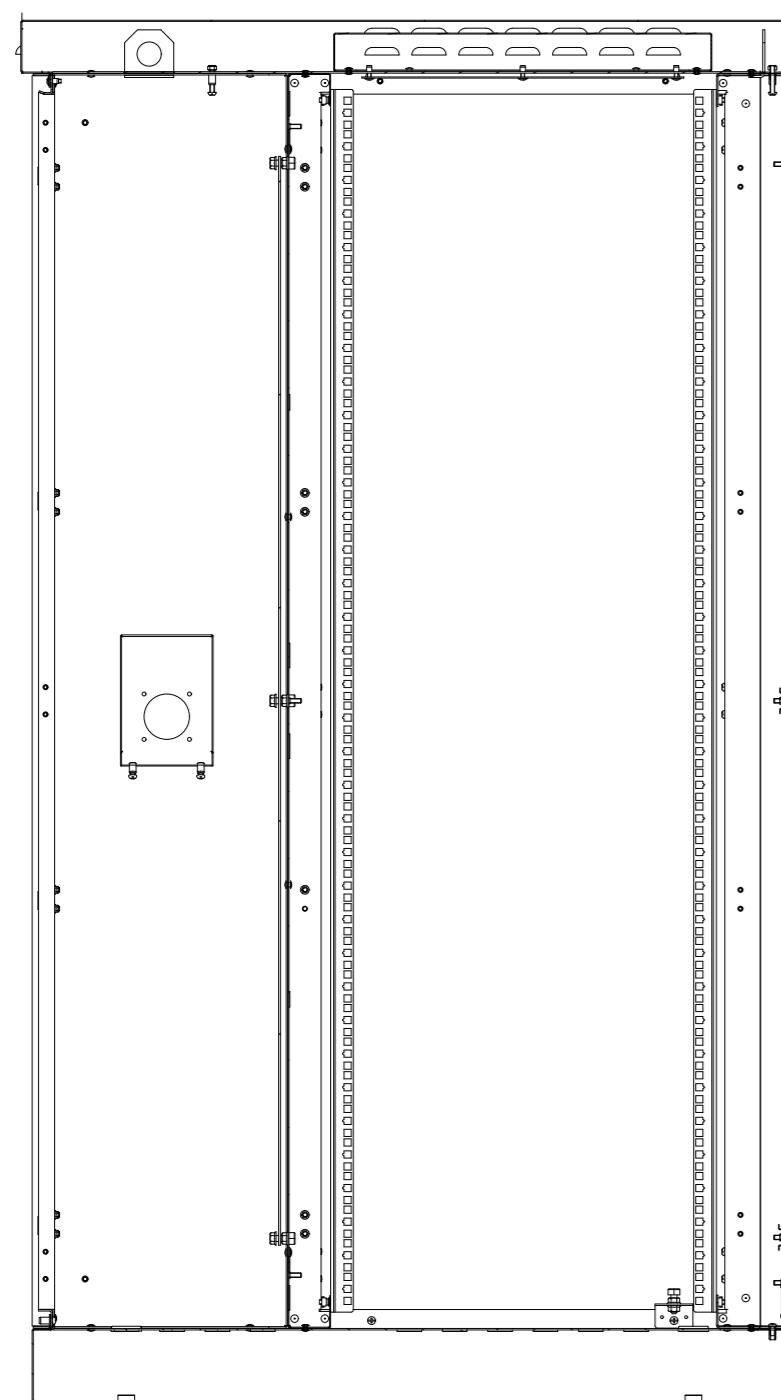

D-D
1:10

Цоколь базовый (высотой 100мм)

Сечение шкафа, каб. вводы

Вид снизу и габариты по крыше

